



Review Article

Investigating Challenges of Using Ammonia as a Future Fuel for Marine Industry: A Review

Kishore Bedekar¹, Erkan Oterkus^{1,*}, Selda Oterkus¹

¹ Department of Naval Architecture, Ocean and Marine Engineering, University of Strathclyde, Glasgow G4 0LZ, United Kingdom

ORCID id: <https://orcid.org/0000-0002-4614-7214>

ABSTRACT

To reduce the greenhouse gases as per the forthcoming IMO rules, ammonia seems to be a suitable fuel for marine industry since it's a hydrogen carrier and a carbon, Sulphur, and particulate matter free fuel. It has high volumetric hydrogen density, low storage pressure, and high auto ignition temperature. Ammonia can be used directly in internal combustion engines, and gas turbines. Cracked hydrogen can be used for fuel cells. The 4th IMO Greenhouse Gas Study 2020, estimates that if no further action is taken, international shipping emissions are expected to represent 90% to 130% of 2008 emission levels by 2050. There will also be a rise in atmospheric CO₂ and there is already a rise in average global sea levels from 21.9 to 23.7 between 1880 and 2010. This will affect large coastal areas of the world and island nations. The challenges for ammonia are its foul odor, corrosive nature, and being highly toxic to humans and the environment. There is also an explosion risk. Other issues are bunkering and storage on board, corrosive effect on metals, shore infrastructure, commercial and technical viability. Therefore, this study gives an overview of challenges that will be faced on board ships to use ammonia as fuel.

Keywords: Ammonia; GHG; IMO regulations; storage; CO₂ free; toxic; corrosive; combustion properties

*CORRESPONDING AUTHOR:

Erkan Oterkus, Department of Naval Architecture, Ocean and Marine Engineering, University of Strathclyde, Glasgow G4 0LZ, United Kingdom; Email: erkan.oterkus@strath.ac.uk

ARTICLE INFO

Received: 8 July 2024 | Revised: 18 August 2024 | Accepted: 16 September 2024 | Published Online: 25 September 2024

DOI: <https://doi.org/10.36956/sms.v6i2.1155>

CITATION

Bedekar, K., Oterkus, E., Oterkus, S., 2024. Investigating Challenges of Using Ammonia as a Future Fuel for Marine Industry: A Review. Sustainable Marine Structures. 6(2): 69-84. DOI: <https://doi.org/10.36956/sms.v6i2.1155>

COPYRIGHT

Copyright © 2024 by the author(s). Published by Nan Yang Academy of Sciences Pte. Ltd. This is an open access article under the Creative Commons Attribution-NonCommercial 4.0 International (CC BY-NC 4.0) License (<https://creativecommons.org/licenses/by-nc/4.0/>).

Nomenclature

| |
|---|
| IMO – International Maritime Organization |
| ICE - Internal combustion engine |
| GHG – Greenhouse gases |
| CO ₂ – Carbon dioxide |
| PPM – Parts per million |
| NO _x – Nitrous oxides |
| SOFC – Solid oxide fuel cell |
| MEPC – Marine Environmental Protection Committee |
| MARPOL – Marine pollution |
| N ₂ O – Nitrous oxide |
| SCR – Selective catalytic reduction |
| LNG – Liquid natural gas |
| HFO – Heavy fuel oil |
| SO _x – Sulphur oxides |
| ISM – International Safety Management |
| IACS – International Association of Classification Societies |
| ABS – American Bureau of Shipping |
| BV – Bureau Veritas |
| DNV – Det Norske Veritas |
| IR – Indian Register of Shipping |
| LR – Lloyds Register of Shipping |
| NK – Nippon Kaiji Kyokai (Class NK) |
| PPE – Personal protection equipment |
| SOPEP – Shipboard oil pollution emergency plan |
| SMPEP – Shipboard marine pollution emergency plan. |
| MELGIP – Main engine liquid / gas injection propylene |
| MELGIM – Main engine liquid / gas injection methanol |
| Type C Tank – Insulated cylindrical, bi-lobe or tri-lobe shaped tanks fully or partially pressurized, depending on the liquefied gas to be stored. Used for LPG carriers. |
| LPG – Liquid petroleum gas |
| HAZID – Hazard identification |
| HAZOP – Hazardous operation |
| EEDI – Energy efficiency design index |

1. Introduction

More than 80% of the world merchandise trade by volume is transported by sea. The use of fossil fuels in marine power systems, main and auxiliary engines contributes about 2.8% of world emissions of greenhouse gases (GHG) to the atmosphere ^[1]. However, maritime transport is also one of the economic sectors with a greater potential to reduce its GHG emissions. For the decarbonization of the maritime sector, it will require consideration of three different fundamental aspects: technology, policy, and investment in research, development, and innovation ^[2].

The IMO Resolution MEPC.377(80) revised IMO GHG strategy as zero carbon emission by 2050 ^[3]. International Maritime Organization (IMO)'s adoption of the initial IMO Strategy on Reduction of Greenhouse Gas Emissions from Ships, Resolution MEPC.304(72) aims to align international shipping with the afore mentioned target. The importance of pursuing efforts to limit the increase in the global average temperature to 1.5°C above pre-industrial levels is to have a greater chance of significantly reducing the risks and impacts of climate change on countries. The aim is to reduce pollution from ships under the International Convention for the Prevention of Pollution from Ships (MARPOL) Annex VI ^[4].

IMO has established rules that limit emissions of pollutants such as NO_x and sulfur oxides (SO_x) ^[5]. To improve the quality of life, clean energy, free of Carbon and Sulphur combustion products, is the prerequisite.

Over the years the world has seen the demand for energy increase and its over dependence upon polluting fossil fuels. Fossil fuel energy supply and demand is also subject to political conditions ^[6]. This fluctuation requires an effective adoption of secondary energy. Moreover, there is no alternative to sea transport which is the most economical way of moving bulk commodities and goods across the oceans.

Ammonia has shown itself to be a promising alternative fuel in the shipping sector. In addition, ammonia-related safety is an established industrial practice in the shipping sector as it is being transported in gas tankers for a long time. Similar safety practices could be adapted / modified towards the use of ammonia as fuel. Large

ocean-going vessels are powered by internal combustion engines (ICE) burning fossil fuel. The only alternative seems to be ammonia as a good hydrogen carrier for use in internal combustion engines. Ammonia offers higher hydrogen density than liquid hydrogen per unit volume, which makes it a more feasible alternative as more hydrogen can be obtained for combustion^[7]. The International Transport Forum (ITF) assumes that, in the case of 80% carbon factor reduction, hydrogen and ammonia will account for around 70% of the fuel market^[8]. The current large-scale ammonia production is very stable as ammonia being a major component in manufacturing agricultural fertilizer. Ammonia storage properties are similar to another commercially used fuel, propane. On the other hand, ammonia combustion could also lead to higher NOx emissions necessitating after treatment or optimizing the combustion process. There is also danger of possible ammonia gas releases. One of the biggest issues is how to handle potential emissions of nitrous oxide (N₂O), which is a powerful greenhouse gas that, if released untreated, would negate the benefits of using ammonia as a fuel. However, Catalysts do exist for N₂O in other industries, and need to develop new solutions fit for maritime applications. SCR at present uses urea, but nitrogen could also be used^[9].

The volume and weight of the required storage infrastructure will impose limitation on the operation range of vessels. Ammonia's lower volumetric efficiency and energy density compared to fossil fuel means much more storage capacity is required on board. This will result in a reduction of cargo and passenger capacity. The additional space required to store and handle ammonia may mean that it is not a viable retrofit option for smaller vessels like coastal cargo vessels, offshore vessels, etc., but can be suitable for large ocean-going vessels. However, with ammonia as main fuel, the requirement of auxiliary machinery required for processing the heavy fuel for proper combustion of oil like separate heated bunker / storage tanks, settling tanks, service tanks, purifiers and clarifiers, associated pumps, heaters, filters and to some extent even the boiler capacity on vessels other than the tankers may be reduced.

Work is ongoing on the regulatory framework and class and flag rules for using ammonia as marine fuel. In-

ternational Association of Classification Societies (IACS) has developed a Unified Requirement (URH1) covering the release of ammonia from the onboard systems for bunkering, storing, preparing, and using ammonia as fuel^[10]. Classification societies have formulated tentative rules/regulations/ guidelines and notations for ammonia fueled vessels including ABS^[11], BV^[12], DNV^[13], IR^[14], LR^[15] and NK^[16].

Ammonia's main advantage is that it doesn't contain any molecular carbon, so combustion process does not produce CO₂ emissions. Its energy potential is also competitive with other marine fuels, with gravimetric energy density of 21.18 MJ/kg^[17]. At present there are no marine engines in service using ammonia as fuel. Engine makers like MAN-B&W^[18], Wartsila^[19], and Win GD^[20] are developing 2 and 4 stroke engines to use ammonia as fuel. These will be dual fuel engines. The future solution will likely be a fuel mix involving LNG, diesel, or methanol. Different blends are being tested and this will have implications for the onboard storage and handling systems.

It is also important to note that no green ammonia has been produced yet. It will be quite some time before green ammonia is produced on a large scale in terms of the volumes needed^[21]. At present ammonia is produced from fossil sources like LNG. The next step will be blue ammonia from carbon capture and further green ammonia from renewables. Ammonia's use as a marine fuel will be in competition for ammonia's use in the fertilizer production. Catering to both industries will necessitate building up more production facilities for ammonia^[22, 23]. Ammonia has great potential as a hydrogen storage option. It has high hydrogen density (17.8 wt.%), along with high flexibility in its utilization, including mobile and stationary applications. Ammonia is suitable to store energy. It liquefies at -33°C and can be stored as liquid and transported as is being done at present in gas tankers for industrial use mainly in the fertiliser and chemical industry and as a refrigerant gas. It can also be stored and transported at 18 bar pressure and atmospheric temperature. There is a well-established global infrastructure to produce, store and transport ammonia worldwide^[24].

At present the International Code of the Construction and Equipment of ships carrying liquified gases in Bulk

(IGC Code) is applicable for ammonia transport. Regulations and procedure for ammonia storage and transport by ships have been well established in the industry. They need to be adopted / modified for use in the marine sector for use of ammonia as fuel. IGC code 16.9.2 stipulates that the use of cargoes identified as toxic products shall not be permitted. Ammonia is listed as toxic.^[25] However, as Ammonia is a liquified gas fuel the IGF code was used as a basis for providing the requirements for the use of ammonia as fuel^[26-28]. While the IMO International Gas Carrier Code (IGC) prohibits the use of cargoes identified as toxic products as fuel for ships, the International Code of Safety for Ship Using Gases or Other Low-flashpoint Fuels (IGF Code) does not cover the case of ammonia. Therefore, a revision of both is needed to allow for the use of ammonia as fuel^[29].

Ammonia needs to be further investigated for its combustion properties for use in ICE, gas turbines and direct ammonia fuel cells. Ammonia ignites and burns poorly compared to other fuels. Flame propagation study will need to be carried out for efficient combustion. Higher NOx emissions and ammonia slip can be dealt with by after treatment or by optimizing combustion. Engine manufacturers like Wartsila and MAN-B&W are already trying out the suitability of ammonia as a fuel in both dual fuel and spark ignition gas engines^[30, 31].

Use of ammonia as fuel will affect how the ships are built as ammonia is less energy dense compared to fossil fuels and requires more storage space compared to fossil fuels, almost 2.5 times. This will reduce the cargo carrying capacity of the ships with financial implications. However, this will be offset by carbon tax levied and over the years the cost of producing green ammonia decreases^[32].

As mentioned earlier, ammonia combustion could also lead to higher NOx emissions necessitating after treatment or by optimizing the combustion process there is also a danger of ammonia gas release. One of the biggest issues is how to handle potential emissions of nitrous oxide (N₂O), which is a powerful greenhouse gas that, if released untreated, would negate the benefits of using ammonia as a fuel. SCR at present uses Urea^[33]. The toxic nature of ammonia is also a major concern. The gas cannot be vented into the surrounding atmosphere in case of leak-

age. However, if there is a leakage there are no operational consequences since the dual fuel engine can switch to using the other main fuel alone^[34].

Classification societies are developing regulations for adopting ammonia as the main fuel as per the IMO guidelines. There is no single silver bullet for decarbonization. New regulations and technology are always disruptive to the existing industry. Future ships will be custom built for propulsion and auxiliary power to use the most appropriate fuel depending on ship type, size, trade route, and cargo carried. For example, small coastal vessels and inland waterways vessels may be hybrid diesel electric or fuel cell powered by hydrogen cracked from ammonia. Training of the ship's crew will be another issue. This will be for handling, bunkering, storage of ammonia and operational / safety issues related to the use of ammonia as fuel in the engine room for main engine, auxiliary engine, and boiler. Perhaps a different certification will be required for handling ammonia as fuel.

However there are ships transporting ammonia for a long time and the crew is well versed in handling ammonia as cargo, but training will be required for use of ammonia as fuel from the operational and machinery maintenance point of view. IMO's Sub-Committee plans to convene an intersessional working group from 9 to 13 September 2024, immediately prior to CCC 10 (subject to approval by the Maritime Safety Committee (MSC) at its 108th session and endorsement by the Council), to finalize the guidelines^[35, 36].

All the above are pertinent issues related to the use of ammonia which need to be investigated as future fuel for the shipping industry.

The major challenges envisaged now can be summarized as (see **Fig. 1**):

- Efficient combustion and specific fuel consumption.
- ICE material specifications of various components like liner, piston, rings, bearings and elastomer seals used in the stuffing box.
- Lubricating oil specifications, effects of ammonia and combustion products on lubricating oil.
- ICE cooling systems.
- Lack of infrastructure for bunkering and onboard bunkering and sampling methods.

- Changes in ships design for storage of ammonia as the energy density is much less than the fossil fuel in use.
- Due to corrosive nature of ammonia its effect on the ship structure, pipelines, valves, venting arrangements etc.
- Toxicity effect on ships crew.
- Toxic effect on marine environment in case of spill-

- age.
- Formulations of new rules and regulations from the class and administration as per the IMO rules.
- Crew training and certification in handling ammonia as fuel.

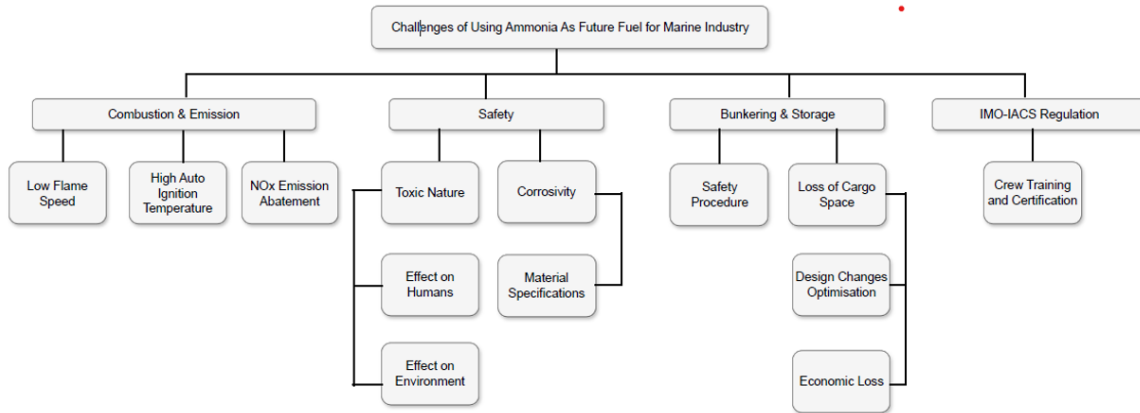

Figure 1. Flow chart – Challenges in using Ammonia as fuel

2. Properties of Ammonia

2.1. Physical Properties

Ammonia is a compound of nitrogen and hydrogen, a colorless gas at atmospheric pressure and normal temperatures with a characteristic pungent odor. At higher pressures ammonia becomes a liquid and is alkaline in nature. It's easier to store and transport ammonia as liquid.

The boiling point is -33.3°C and hence by applying moderate pressure it can be handled as a liquid at room temperature. At pressures above 8.6 bar at 20°C , ammonia is a liquid with a density of 0.61 t/m³. At the boiling point, the density is 0.68 t/m³. The heating value for ammonia on a lower heating value basis is 18.6 MJ/kg. Thus, compared to MGO the energy content is less than half on a mass basis and about 30% on a volume basis in liquid state.

The typical heating value for ammonia is similar to that of methanol. As with most alternative fuels, it has a lower energy density than fuel oils, so producing the same energy content would require about 2.4 times more volume as compared to petroleum-based fuels. Ammonia is being produced by the Haber Bosch process for the last hundred years. LNG being the feedstock, 30 GJ of natu-

ral gas energy is needed to produce one thousand tons of ammonia. For every ton of Ammonia produced 1.87 tons of CO₂ is emitted. This is what is known as Brown Ammonia. Carbon capture and storage will result in blue ammonia and green ammonia will be the result of production from renewable energy without any carbon footprint^[37,38].

Table 1. Characteristics of Ammonia

| Properties | Unit | Value |
|--|---------------------------------|----------------|
| Colour | - | Colourless |
| Odour | - | Sharp, pungent |
| Molar mass | g/mol | 17.031 |
| Density @ STP | kg/m ³ | 0.769 |
| Melting point | $^{\circ}\text{C}$ | -77.73 |
| Boiling point at 100 kPa | $^{\circ}\text{C}$ | -33.4 |
| Vapor pressure at 20°C | kPa | 858 |
| Heat of evaporation | MJ/kg | 1.371 |
| Critical temperature | $^{\circ}\text{C}$ | 132.4 |
| Critical pressure | MPa | 11.28 |
| Viscosity at 25°C | $\mu\text{Pa}\cdot\text{s}$ | 10.07 |
| Heat capacity at c.p. (101.325 kPa, 15°C) | $\text{kJ}\cdot\text{mol}^{-1}$ | 0.037 |
| Heat capacity at c.v. (101.325 kPa, 15°C) | $\text{kJ}\cdot\text{mol}^{-1}$ | 0.028 |
| Heat of combustion | MJ/L | 11.2 |
| Thermal conductivity | $\text{mW}\cdot\text{m}^{-1}$ | 22.19 |
| Critical density | g/mL | 0.24 |
| Condensation pressure at 25°C | MPa | 0.99 |
| Flammability limit (equivalence ratio) | - | 0.63–1.4 |
| Adiabatic flame temperature | $^{\circ}\text{C}$ | 1800 |
| Max. laminar burning velocity | m/s | 0.07 |

2.2. Chemical and Physical Properties

Anhydrous ammonia is a colorless non-flammable liquified gas. Its vapor is lighter than air (vapor density of 0.6) whereas air density is 1. The vapor leak may hug the ground appearing as white cloud. Chemically ammonia is 82% nitrogen (N) and 18% hydrogen (H) and has the chemical formula of NH_3 .

Reaction to water – Ammonia is hydroscopic 1:1300 ratio (water: vapor) ammonia reacts with water forming ammonium hydroxide (NH_4OH). Ammonia is very soluble in water with no layering effect.

Flammability: Ammonia is nonflammable but will ignite at 600°C within vapour concentration limits of 15% to 28%.

Corrosiveness: Ammonia will corrode galvanized metals, cast iron, copper, brass, or copper alloys. All ammonia piping, valves, tanks, and fittings are constructed of steel. Liquid ammonia will expand 850 times into gaseous state.

2.3. Combustion Properties

Ammonia is a simple chemical molecule compared to HFO fuel oil derived from crude oil. Ammonia will combust more efficiently as there are no other complex hydrocarbon chains like marine HFOs. Ammonia has a high auto ignition temperature of 650°C . It has low flame speed and high heat of vaporization. It has narrow flammability limits of 16-25% by volume in air. Ammonia is more suitable for lower engine speeds due to its low flame speed and hence better use in 2-Stroke slow speed marine engines. Ammonia is a monofuel and requires a high compression ratio of 35:1. It has a significantly higher combustion heat, 11.2 MJ/L, compared to liquid hydrogen (8.58 MJ/L). As per MAN-B&W, it is established that ammonia liquid supply pressure for combustion approximately 80 bar and injection pressure 600-700 bar^[39].

Ammonia has a high-octane rating and high compression ratios are possible without undesirable knocking. Furthermore, it has a lower stoichiometric air-fuel ratio compared with diesel and for the same amount of air, more ammonia can be introduced and thereby compensate for

the lower energy content and maintain the power density of the engine. The lower flame speed and narrow flammability range may lead to unburnt ammonia and hence ammonia slip. Flame behavior in the engine is still under investigation^[40].

Internal combustion engines are considered as a better option than fuel cells in the near future because of cost, power density, load response, and robustness. Two-stroke diesel engines are the preferred main propulsion systems for large ships. The large combustion chamber and the long stroke with low rpm of a two-stroke engine is quite suitable for burning ammonia.

In their DEMO 2000 project, Wärtislä and partners used 30% marine diesel oil in ammonia for its first successful tests in a four-stroke engine, but it is unclear whether this will be applicable to two-strokes^[41].

Exothermic combustion reaction:

$4 \text{NH}_3 + 3 \text{O}_2 \rightarrow 2 \text{N}_2 + 6 \text{H}_2\text{O} + \text{Heat}$ (Exothermic reaction)

NOX emission reduction can be achieved by selective catalytic reduction system. NH_3 injected into the exhaust gas produces only N_2 and water as waste.

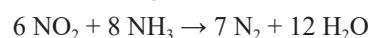
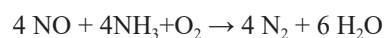

NH_3 combustion will not emit CO_2 , SO_x , and particulate matter.

There are number of parameters unknown about ammonia; namely the best air fuel ratio for good efficient combustion, temperatures of combustion, the effect on cylinder liner walls, heat transfer rate from the liner to cooling medium, the interaction between combustion products and cylinder lubricating oil, in case of blow past the effect on piston rings and stuffing box components.

Cylinder oil is used as lubricant between liner walls and piston rings. It also serves to seal the space between the ring and liner wall, preventing pressurized combustion gas passing by. If the sealing is not proper due to improper lubrication, then what is known as blow past occurs. If there is unburnt ammonia in the blow past, then its effect on the piston rings and stuffing box is unknown. This stuffing box contains bronze / brass gas sealing rings, oil scraper rings and rubber gaskets. All these components will have to be compatible with ammonia. Furthermore, if

ammonia enters the crankcase, then its effect on the system oil is also unknown.

The present lubricants are meant for fossil fuel and not for ammonia. The chemical requirement of lubricant will be different once the ammonia effects are known. The impact of ammonia fuel on marine engine lubricating oil is still under investigation^[42].

2.4. Corrosive Properties

Ammonia is incompatible with various industrial materials, and in the presence of moisture reacts with and corrodes copper, brass, zinc, and various alloys forming a greenish / blue color. Ammonia is an alkaline reducing agent and reacts with acids, halogens, and oxidizing agents. Selection of materials will be an important factor when ammonia is used onboard a vessel. Iron, steel, and specific non-ferrous alloys resistant to ammonia should be used for tanks, pipelines, and structural components where ammonia is used. Ammonia is known to cause stress corrosion cracking in carbon manganese and nickel steels.

Stress corrosion cracking is induced and proceeds rapidly at high temperatures in steel when oxygen levels of more than a few ppm in liquid ammonia are introduced. Ammonia is also reactive to CO₂ that may be contained in inert gas^[43]. The IGC Code outlines the requirements for piping components, cargo tanks and equipment in contact with ammonia liquid or vapor^[44].

2.5 Toxic Properties

Ammonia is toxic in nature and has a distinctly pungent and suffocating odor. The typical detection limit by humans varies considerably from 0.04 to 53 ppm with a mean of 17 ppm. Hence, the detection limit may be above concentration considered as dangerous for long term exposure.

Ammonia solutions with water have a strong alkali reaction. Being extremely soluble, ammonia is absorbed by body fluids (sweat, tears, saliva) and may cause severe chemical burns.

Table 2. AEGL values for Ammonia^[68]

| Classification | 10 min | 30 min | 1 h | 4 h | 8 h | End Point (Reference) |
|-----------------------|---|---|---------------------------------------|-------------------------------------|-------------------------------------|--|
| AEGL-1 (nondisabling) | 30 ppm (21 mg/m ³) | 30 ppm (21 mg/m ³) | 30 ppm (21 mg/m ³) | 30 ppm (21 mg/m ³) | 30 ppm (21 mg/m ³) | Mild irritation (MacEwen et al. 1970) |
| AEGL-2 (disabling) | 220 ppm (154 mg/m ³) | 220 ppm (154 mg/m ³) | 160 ppm (112 mg/m ³) | 110 ppm (77 mg/m ³) | 110 ppm (77 mg/m ³) | Irritation: eyes and throat; urge to cough (Verberk 1977) |
| AEGL-3 (lethal) | 2,700 ppm (1,888 mg/m ³) | 1,600 ppm (1,119 mg/m ³) | 1,100 ppm (769 mg/m ³) | 550 ppm (385 mg/m ³) | 390 ppm (273 mg/m ³) | Lethality (Kapeghian et al. 1982; MacEwen and Vernot 1972) |

AEGL values are the values of acute exposure guideline levels, they represent threshold exposure limits for the public and are applicable to emergency exposure periods ranging from 10 minutes (min) to 8 hours (h). Three levels—AEGL-1, AEGL-2, and AEGL-3—are developed for each of five exposure periods (10 min, 30 min, 1 h, 4 h, and 8 h) and are distinguished by varying degrees of severity of toxic effects.

3. Internal Engine Process

Present internal combustion engines use fossil fuels like LSHFO and MGO. Marine propulsion engine is normally a 2-Stroke crosshead engine. The combustion

process is based on diesel cycle. One revolution encompasses compression-combustion-power stroke and exhaust. Heated fuel for the required viscosity is injected at high pressure range of about 350 bar, a few degrees before the piston reaches TDC this atomised fuel self-combusts (auto ignition) due to mixing with high temperature of compressed air resulting in combustion process creating high pressure and temperature above the piston giving a power stroke. Ammonia combustion properties are poor compared to fossil fuels and require modification to the engine. Ammonia has low flame speed and a high auto ignition temperature of 651°C. Ammonia does not auto combust at low temperatures and requires the use of pilot fuel like MGO or bio-diesel to initiate combustion process.

3.1. Engine arrangement

As per Man-B&W, engines used for gas injection can be modified to use ammonia. To use ammonia as fuel and for proper combustion, it will be injected as gas under high pressure and ignited by a pilot flame using MGO or bio-

diesel for complete combustion. There are existing engines using dual fuel like LNG and Methanol and these can be modified to use ammonia as fuel as per the engine makers. The diagram shows the modification for using ammonia as fuel.

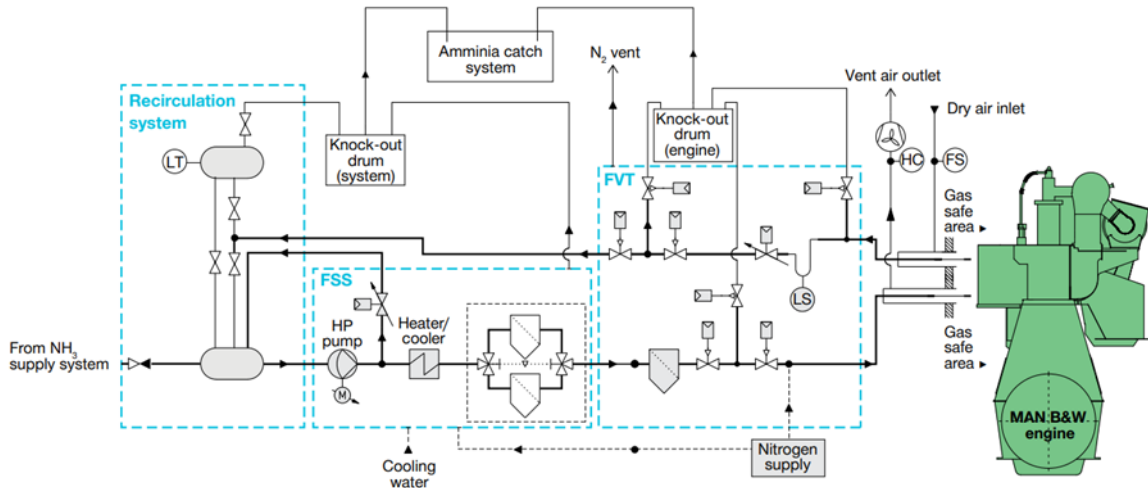

Figure 2. MAN B&W Dual Fuel engine [46]

3.2. NOx emission

NOx emission can be controlled by selective reduction catalyst (SCR) process with urea and ammonia. Formation can be controlled by modifying the combustion process. Part of exhaust gas is redirected to the scavenge air receiver cooled and used again.

Normally, the ammonia (reducing agent) required is added by injecting a urea solution ($\text{CH}_4\text{N}_2\text{O} + \text{H}_2\text{O}$) into the exhaust gas, however, ammonia can be injected as the catalytic agent instead of urea. The consumption of ammonia for the SCR system will be very small compared to the ammonia fuel consumption [46].

NOx emission – ammonia.

Selective Catalytic Reduction (SCR) Process – removing NOx emissions

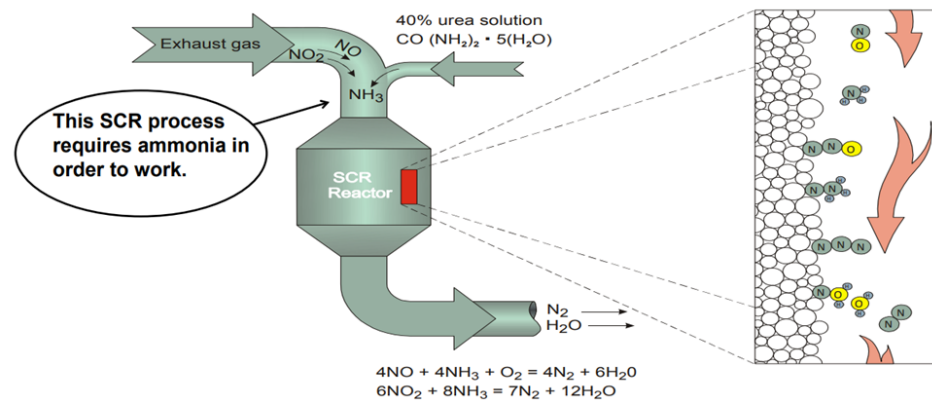

Fig. 3 Selective catalytic reduction using ammonia as catalyst [46]

3.3. Safety

Due to ammonia's toxic nature any leak will be dangerous for humans. As per NIOSH PEL (Permissible) limit is 50 ppm^[47]. Since ammonia is a toxic chemical, proper safety precautions must be observed. Ammonia has been handled routinely as part of the SCR system on many vessels. The fuel pipes on the ammonia engine are double walled and the design of the outer shielding pipe prevents gas outflow to machinery spaces in the event of a leakage or rupture of the inner gas pipe. A separate mechanical ventilation system with a capacity of 30 air changes per hour vents the intervening gas pipe space, including the space around valves, flanges, etc. Any leaking gas is led to the ventilated part of the pipe system, where hydrocarbon sensors will detect it^[48].

3.4. Engine lubrication

Ammonia is a toxic substance that has never been used as a fuel in the laboratories of most lubricants or additives companies. New test methods will need to be developed when ammonia is used as fuel. It is known that LNG flame can burn down the sides of piston crown and lead to deposit formation between and behind the piston rings. Methanol used as fuel in the engines formed emulsion with system lubricating oil, but effects of ammonia are unknown.

lubricating oil, but the effects of ammonia are unknown. Lubricating oil and additive producing companies need a representative fuel available for testing, required for developing / producing the right lubricating oil for ammonia engines. Ammonia will require a different type of lubricating oil for cylinder lubrication.

Due to ammonia's poor combustion qualities and the delay in combustion the effect on cylinder lubrication is unknown and is an area of concern. The type of additives required is still an unknown area. It will depend on the combustion process and products action with the base lubricating oil. Effects of ammonia and combustion products on cylinder lubrication and engine crank case oil needs investigation. The impact of ammonia on engine oil degradation is still an unknown quantity^[49]. The possibility of

lubricating oil getting contaminated and its effect on film formation also needs to be studied. Oil analysis process will also change, as of today they are all based on the use of fossil fuels in the engines.

Combustion Related Corrosion: Ammonia combustion products are Nitrogen, NOx, unburnt ammonia, and water vapor and all these can lead to corrosion. Engine components need to be compatible with the fuel used. Engine parts are made of cast iron, cast steel, aluminum, copper, nickel, bronze, white metal, neoprene rubber, Teflon etc. The effect of ammonia will need to be investigated.

Lubricant Properties: A study investigated the impact of ammonia combustion on engine lubrication. A 4-stroke diesel internal combustion engine was modified to operate in dual-fuel mode with ammonia. Different engine lubricants were tested, and oil samples were taken over extended periods. Analytical techniques and laboratory tests evaluated the evolution of lubricant properties under ammonia-powered engine operations. The study provided insights on compatibility of engine oil composition with ammonia^[50].

3.5. Main engine components

Materials used in the engine should not be affected by the corrosive nature of ammonia, especially applicable to elastomer seals used in the stuffing box and areas where sealing between two components is required. Ammonia compatibility with elastomer seals viz. stuffing box arrangement is another area which needs investigation.

3.6. Engine cooling arrangements

The conditions in the cylinder, temperature and pressure developed and suitable cooling arrangement of liner and cylinder head are still under investigation. Ammonia combustion properties and temperatures in the cylinder after combustion will dictate the cooling gradient of the cylinder liner wall and the temperature of cooling medium.

3.7. Scavenge air pressure and temperature

Pressurized scavenge air is provided by the exhaust gas turbocharger which is cooled and supplied to the un-

der-piston area for providing scavenge air to remove the exhaust gas and fresh air for clean combustion. The pressure and temperature will depend on what kind of combustion takes place in the cylinder and the ratio of pilot fuel used for initial ignition. For complete combustion correct air / fuel ratio is required, to prevent any ammonia slip. Pressurized cooled air is supplied by the turbocharger into scavenge duct through an air cooler into the under-piston area. Since the combustion properties of fossil fuel and ammonia are different the required air quantity may differ both in temperature and pressure provided. Ammonia has lower flame speed and high combustion temperature, compared to fossil fuel.

3.8. Turbocharger

The turbocharger design may need to be modified to supply the right amount of air pressure charge to the engine depending on the combustion process and the consequent temperature and pressure of exhaust gas.

4. Issues Foreseen Onboard and for Vessel Operation

For crew safety, operational guidance will need to be provided through a check list and part of ISM manuals. Separate guidelines will be required for bunkering and maintenance of engines using the appropriate PPE. At present SOPEP guidelines are being followed for any spillage of fuel oils during bunkering and equipment provided for same. Similarly, a “Ship Ammonia Pollution Emergency Plan” will need to be formulated and special equipment should be provided for dealing with ammonia leakage / spills. At present ships certified to carry oil and noxious liquid substances have Shipboard Marine Pollution Emergency Plan (SMPEP) in accordance with regulation 37 of Annex I and regulation of 17 of Annex II. This may need to be modified for carrying ammonia as fuel.

5. Environment Protection

In case of spillage during bunkering, procedures and methodology will need to be developed to prevent pollu-

tion of sea, waterways, rivers etc. ISM manuals will have to incorporate the procedures and check list. Ammonia spillage in water will affect aquatic life. Even at diluted concentrations it is highly toxic to aquatic life and is classified as dangerous for the environment.

Ammonia affects the fish both directly and indirectly depending on the levels present, with certain species more susceptible to ammonia toxicity than others. At lower concentrations, around 0.05mg/L, un-ionized ammonia is harmful to fish species and can result in poor growth and feed conversion rates, reduced fecundity and fertility and increase stress and susceptibility to bacterial infections and diseases. At higher concentrations, exceeding 2.0mg/L, ammonia causes gill and tissue damage, extreme lethargy, and death.

Ammonia density is 0.86 compared to air (1.0). Although it is lighter than air it forms a cloud with atmospheric air and stays at ground level as white fog. It is also highly hygroscopic, meaning it has high affinity with water and dissolves in water. Once it is in water nothing can be done. The only way is prevention of spillage in water^[51].

6. Storage Onboard and Bunkering

Safe storage of ammonia onboard needs to be investigated as well. It can be either stored in refrigerated, semi-refrigerated or pressurized tanks. This design will depend on the ship type and spaces available for safe storage. This will cut down the cargo space. Ammonia will occupy almost 2.5 times the space required compared to fossil fuel with the same energy output. However, for fuel oil use all the associated tanks like settling tanks, service tanks, associated heating and pumping equipment, hot filters, associated piping valves and control systems will not be required. The fuel oil purifiers will also become redundant along with their associated equipment vacating the space required in the engine room. The anticipated choice for storing ammonia for use as propulsion fuel is likely to be a pressurized tank Type C, at ambient temperature and app. 18 bar pressure^[13].

Venting arrangements are also an important issue. Ventilation is required for storage tanks and fuel preparation room areas. It should be designed to avoid exposure

to crew outside those areas. Just like chemical and petroleum tankers ventilation and access doors to accommodation needs to be designed to avoid any gas ingress. Perhaps this can be achieved by double door construction and positive pressure slightly higher than the atmospheric pressure in the accommodation. A gas detection / alarm system in the accommodation will be required for additional safety. The location of vent masts should be away from the accommodation and air intakes.

Bunkering procedures need to be formulated for safe bunkering. Ship specific manuals and instructions for safe bunkering procedures will be required. Normally bunkering is concurrent with cargo operation. Ports should have adequate facilities for bunkering and their own procedures for safe bunkering. The ullages and measurements process will differ from the one used for fossil fuel.

Infrastructure for bunkering in large quantities will need to be developed. There must be an international standard for quantity and quality assessment.

Ammonia can react with halogens, interhalogens and oxidizers and may cause violent reactions or explosions. Therefore, ammonia should be stored in a cool, well-ventilated location, away from sources of ignition, and separate from other chemicals, particularly oxidizing gases (chlorine, bromine, and iodine) and acids.

The IGC Code (Chapter 16 Use of Cargo as Fuel) applies to liquefied gas carriers using their cargo as fuel under the 'one ship, one code' amendments to SOLAS II-1 made with the adoption of the IGF Code. However, the IGC Code, Chapter 16.9.2 prohibits the consumption of toxic cargoes, including ammonia, as fuel. Current proposals to amend the clause could be approved by December 2024 at the earliest.

As per the IGC code the following requirements need to be fulfilled ^[52].

Personal Protection (14.4): Self-contained breathing apparatus and gas-tight protective clothing for all onboard personnel, and decontamination of shower facilities.

Material compatibility (17.2.1): Materials to be resistant to the corrosive action of gases and materials such as mercury, copper and copper-bearing alloys, and zinc not to be used for construction of cargo tanks and associated pipelines, valves, fittings, and other items of equipment

normally in direct contact with the cargo liquid or vapor.

Stress Corrosion Cracking (17.12): Requirements to minimize the risk of stress corrosion cracking in containment and process systems made of carbon manganese steel or nickel steel.

7. Crew Training and Certification

At present ships are carrying ammonia as cargo on gas tankers. The crew is certified for carriage of this type of toxic cargo. However new rules and regulations will need to be formulated for using ammonia as ship's fuel considering IGF and IGC codes. Crew will need to be trained to use ammonia as fuel. This will include handling ammonia and maintenance of engines using ammonia as fuel and all the safety aspects related to it. Administration will have to issue certificates for crew using ammonia as fuel.

8. Firefighting Arrangements for Ammonia

Ammonia is a flammable gas with a narrow flammability range. Its flammable range in dry air is between 15.15% and 27.35%. It has an auto ignition temperature of 651°C. The risk of an ammonia fire is lower compared to other fuels due to its narrow flammability range, relatively high ignition energy, and low laminar burning rate (more than four times less than methane [< 0.010 m/s]). However, ammonia needs to be isolated from any possible ignition source. The fire risks of ammonia when mixed with other fuels and lubricating oils need to be investigated in addition to pure ammonia combustion. Such fuel mixtures may have a much broader explosive range. Ammonia fire will produce irritating, corrosive and / or toxic gas.

Dilution systems may be utilized to avoid the flammability range of ammonia. The United States National Center for Biotechnology Information recommends that small fires involving ammonia can be extinguished with dry chemicals or CO₂ and large ammonia fires can be extinguished through water spray, fog, or foam but care needs to be taken to prevent environmental contamination from diluted water/runoff ^[53].

9. Overall Risk Management

Ship specific proper HAZID, HAZOP and Risk analysis will be required, formulated, and check lists incorporated in the operation manuals. Ammonia detection Alarm / systems will need to be installed for the system.

A new building will be easier than retrofit. However, MAN-B&W claims that present engines running on liquid gas injection of propane and methanol can be modified to run on ammonia^[54]. There will be new design concepts for ships in view of the larger capacity of bunker tanks associated pipelines, valves, and venting arrangements. The ME-LGIM engine type, which uses methanol as fuel, has been in service for some time and has achieved 50,000 running hours on methanol. The LGIM concept is used as basis for the LGIP engine, which uses LPG as fuel and is now being adapted to use ammonia as fuel. The development of the LGIM engine also dealt with some of the challenges related to ammonia, e.g. corrosion, toxicity, and low flammability. The same engine concept, already verified at sea, will constitute the core of the ammonia-combusting engine. There will be no visible differences between an ammonia and an ME-LGIP/LGIM engine^[54].

Ammonia tanks need to be designed for temperature and/or pressure control if ammonia is stored in a refrigerated condition, as ammonia continuously evaporates and generates boil-off gas due to heat gain, which increases pressure in tanks if not managed. Challenges like crew training, bunkering availability, port discharge limit compliance, tank venting and planning for human exposure beyond permissible limits need to be addressed during the hazard identification study when designing^[55].

10. Ammonia for Fuel Cell – Solid Oxide Fuel Cell (SOFC)

The SOFC can directly use NH₃ as fuel; however, the SOFC is limited in how rapidly it can increase fuel delivery rate according to power demand. Therefore, the energy storage system (ESS) is utilized as a complement (back-up) power to compensate for the slow dynamics of the SOFC during transient operations, and it can also be used as a cold-start energy source. The ESS is charged through the

remaining power at an instantaneous load reduction, and it discharges at an instantaneous load increase. The ESS can cope with the extra load fluctuations, especially for high load conditions (e.g. heavy weather, etc.).

Ammonia can also be split into nitrogen and hydrogen via the reaction

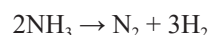

Ammonia used in fuel cells may offer higher thermal efficiencies, less noise, vibrations, and lower emissions of air pollutants compared to ICE. However, the emissions associated with ammonia fuel cells need to be investigated. There is a risk of NO_x emission^[57]. The ammonia fuel cell will also be relatively costly.

11. Present Status

MAN B&W claims no visible difference between ammonia and ME LGIP / LGIM liquid gas injection of propane and methane gas. Following two years of exploratory studies into the economic feasibility of deploying 100% ammonia-fired gas turbines across Asia, GE Vernova and IHI Corporation will proceed to an engineering and testing phase. Based on their efforts in 2022 to demonstrate a low-N₂O combustor for a 2 MW, 100% ammonia-fired turbine, IHI will lead development of a two-stage combustor for larger-scale gas turbine models. Combustion testing will take place in IHI's facilities in Japan. As per MAN - B&W, 3000 engines can eventually be converted to ammonia operation^[59].

Alfa Laval, which is one of the marine fuel system developers, announced that it is exploring the next generation of fuel gas supply systems to accommodate LPG and eventually ammonia for engines^[60]. In January 2020, a new project (Ship FC) was launched to install the world's first ammonia-fueled fuel cell on an offshore vessel (Viking Energy)^[61]. In addition, some research works^[62,63] mentioned ammonia to be the main fuel for polymer electrolyte membrane fuel cells (PEMFCs) as a low-cost approach. There are already some 170 ships in operation that can carry ammonia, with around 40 of these continually carrying the product.

IMO Report:

As per the IMO report, at present fossil fuels are in use along with LNG.

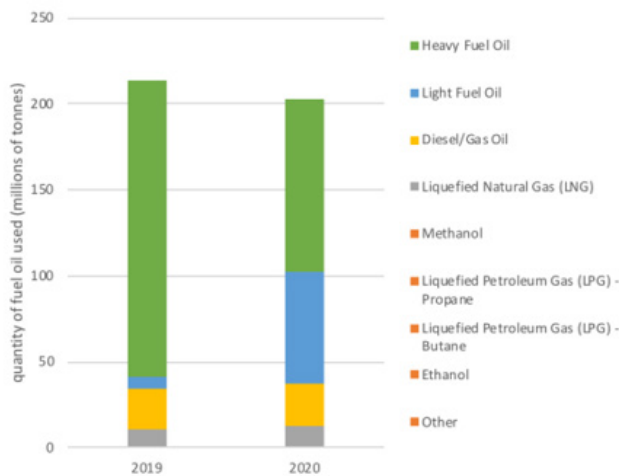

Figure 4. Fuel Oil consumption of Ships ^[64]

As per the report, 27723 ships used 203 million tons of fossil fuel in 2020. There was a slight increase in the use of Liquefied Natural Gas (LNG), which was 11,974,761 tons in 2020 (compared to 10,482,742 tons in 2019). 99.91% of the fuel used was either Heavy Fuel Oil, Light Fuel Oil, Diesel/Gas Oil or Liquefied Natural Gas. The majority of the reported fuel oil was consumed by the following three EEDI ship types, containerships, bulk carriers, and tankers.

Advantages

Advantages of ammonia as a fuel can be summarized as:

- Ammonia is carbon free so there is no CO₂ or soot emission. It can be easily reformed to hydrogen and nitrogen for direct use in fuel cells. It can be stored and transported as a liquid at a practical pressure and temperature.

- Use of ammonia in ICE is capable of achieving IMO decarbonising target for shipping by 2050.

- Excess electrical energy produced by renewables like wind and solar can be used to synthesize green ammonia and stored, to be used as required. Infrastructure exists for ammonia for storage and transport.

- Lloyd's Register (LR) and University Maritime Advisory Services (UMAS) ^[65] suggest that ammonia is more competitive than hydrogen because of the lower costs that are associated with onboard storage.

Disadvantages

Disadvantages of ammonia as a fuel can be described as:

- Ammonia's corrosive and toxic nature is harmful to humans, environment, and marine life.

- High NO_x generation will need to be handled.

- Safety is a major concern.

- Lack of infrastructure to supply on large scale. Bunkering facilities will need to be developed.

- Complete ship design will change, and ICEs will need to be modified. Design criteria will be suitable for how to deal with equipment failure and cascading failures.

- New rules and regulations will need to be formulated for safe handling. Crew and shore / port personnel will need to be trained to handle ammonia as fuel. Good training and certification will be essential to reduce human error.

- For comparison, the fuel consumption of all ships was estimated to be 300 million tons in 2012, which corresponds to 650 million tons of ammonia on an energy basis. Since shipping fuel demand is also expected to increase further the current production of ammonia can only cover a moderate fraction of the demand for marine fuels ^[66].

- Present production will require upscaling as ammonia^[67] is extensively used for agriculture fertilizer essential for food production worldwide.

12. Conclusions

Ammonia is a carbon, Sulphur and other pollutant free fuel that will play an important role in the decarbonization of shipping as per IMO regulations. Ammonia is toxic and corrosive in nature, the energy density is lower than fossil fuels, but it is still more favorable than hydrogen. With modified internal combustion engines and low-pressure fuel tanks it will be suitable for large ocean-going vessels. Due to its high toxicity and corrosiveness appropriate safety barriers need to be in place and material selection for various components using ammonia as fuel is of importance.

The operation of alternative-fuel-powered ships like ammonia has some special risks, such as fuel spills, va-

por dispersion, and fires. The existing international legal framework does not address these risks sufficiently. Unforeseeable damage to environment, human health, and property due to spillage of toxic ammonia has a legal aspect from international law perspective, related risks, and solutions^[67].

The cost of producing ammonia-based fuels by renewable energy is being explored. When used as fuel in IC engines, ammonia combustion predominantly produces water and nitrogen. Unburnt ammonia must be closely controlled. Understanding the requirements of ammonia gas including low-temperature service, pressurized storage tanks, flammable gases, and working with corrosive and toxic nature is key to addressing the safety hazards of using ammonia as a fuel for marine engines.

Author Contributions

Kishore Bedekar: Conceptualisation, Methodology, Data Analysis, Original Draft Preparation; Erkan Oterkus: Conceptualisation, Methodology, Data Analysis, Writing-Editing, Supervision; Selda Oterkus: Conceptualisation, Methodology, Data Analysis, Writing-Editing, Supervision.

Funding

This research received no external funding

Data Availability

Data will be available upon request.

Conflict of Interest

All authors disclosed no any conflict of interest.

References

- [1] Faber, J. et al. (2021), Fourth IMO GHG Study 2020, International Maritime Organization (IMO).
- [2] Estela Morante, Article No. 99 [UNCTAD Transport and Trade Facilitation Newsletter N°96 - Fourth Quarter 2022] – 19th Dec. 2022
- [3] IMO Resolution MEPC.377(80)
- [4] Prevention of Air Pollution from Ships', International Maritime Organization, UK:<http://www.imo.org/en/OurWork/Environment/PollutionPrevention/AirPollution/Pages/Air-Pollution.aspx> [Google Scholar]
- [5] Sulphur Oxides (SOx) and Particulate Matter (PM) – Regulation 14', IMO, UK:[http://www.imo.org/en/OurWork/Environment/PollutionPrevention/AirPollution/Pages/Sulphur-oxides-\(SOx\)-%E2%80%93-Regulation-14.aspx](http://www.imo.org/en/OurWork/Environment/PollutionPrevention/AirPollution/Pages/Sulphur-oxides-(SOx)-%E2%80%93-Regulation-14.aspx)[-Google Scholar]
- [6] PNAS - Political leadership has limited impact on fossil fuel taxes and subsidies <https://doi.org/10.1073/pnas.2208024119> - November 14, 2022, Cesar B. Martinez-Alvarez, Chad Hazlett, Pasha Mahdavi, and Michael L. Ross
- [7] Limitations of Ammonia as a Hydrogen carrier for the transport sector – ACS Energy letter- 2021, 6, 4390-4394 S. Chatterjee, R.K. Parsapur, Kuo-Wei Huang
- [8] The International Transport Forum (ITF). Decarbonising Maritime Transport Pathways to Zero-Carbon Shipping by 2035; OECD: Paris, France, 2018.
- [9] Ammonia Energy Association, Ammonia for power: a literature review – By Trevor Brown Oct.04,2018
- [10] International Association of Classification Societies – URH 1
- [11] ABS - Ammonia as Marine Fuel White paper – October 2020
- [12] Bureau Veritas – NR 671 RO1
- [13] Det Norske Veritas, White paper 2020
- [14] Indian Register of Shipping Guidelines on Ammonia fueled vessels – December 2022
- [15] LRS - Rules and Regulations for the Classification of Ships using Gases or other Low-flashpoint Fuels, July 2022 - Chapter 1 Appendices
- [16] NK – Part C – Guidelines for the safety of Ships using ammonia as fuel. https://www.classnk.or.jp/hp/pdf/research/rd/2022/05_e07.pdf
- [17] Article- Ammonia for power: A literature review, Trevor Brown Oct4, 2018, Ammonia Energy Association.
- [18] MAN ES technical paper, Engineering the future two-stroke green-ammonia engine, November 2019
- [19] Wartsila - Article-swz-maritime-magazine-types-of-fuel- March 2020., Safe and effective operation of engines with Ammonia and Methanol 19th International Maritime Conference 2023 Tallinn. Fredrik Lindfors, Wärtsilä Marine Power Supply, R&D and Engineering, 4th of October 2023
- [20] WinGD - TIN035 Dual-Fuel-Ammonia-Engine-Development Dec. 2023 Technical information note 035

- [21] Linde Engineering Green seminar 2021
- [22] Yara International Ammonia You tube video
- [23] Stargate White paper
- [24] Ammonia : Zero carbon fertiliser, fuel, and energy store policy briefing – The Royal Society].
- [25] IMO Resolution MSC5(48) IGC code 16.9.2 <https://www.imo.org/en/OurWork/Safety/Pages/IGC-Code>.
- [26] Class NK : https://www.classnk.or.jp/hp/pdf/research/rd/2022/05_e07.pdf
- [27] MARPOL : <http://www.marpoltraining.com/Annex-II-Regulations-for-the-Control-of-Pollution-by-Noxious-Liquid-Substances-in-Bulk-Chapter-1-Reg.-5>,
- [28] Maritime Technologies forum - Preliminary discussion report on the use of ammonia as fuel for ships. www.maritimetechnologiesforum.com/documents/ammonia-report.pdf
- [29] Ammonfuel article – An industrial view of ammonia as a marine fuel 59 / 61 August 2020
- [30] <https://shippingwatch.com/regulation/article15928061.ece> Shipping watch article - Wartsila test-runs 90 percent ammonia-fueled engine
- [31] MAN-B&W -
- [32] The impossible love of fossil fuel companies for carbon taxes – Elsevier Ecological Economics, Alain Naef 2 Nov. 23, 27 – Putting a price on pollution-Ian Perry De. 2019], IMF article
- [33] SCR - MAN Energy solutions- https://www.man-es.com/marine/solutions/exhaust_gas_after_treatment_systems?utm_medium.
- [34] MAN-B&W: Two stroke engine operating on ammonia – Future in the making – White paper
- [35] Progress on safety guidelines for hydrogen- and ammonia-fuelled ships <https://www.imo.org/en/MediaCentre/Pages/WhatsNew-1968.aspx> - 05 October 2023
- [36] <https://www.seatrade-maritime.com/sustainability-green-technology/alternative-fuels-training-needed-800000-seafarers-mid-2030s> Marcus Hand Nov. 09, 2022 Article
- [37] Department of agriculture. (<https://www.mda.state.mn.us/physical-chemical-properties-anhydrous-ammonia>)
- [38] Decarbonization in ammonia production, new technological methods in industrial scale ammonia production and critical evaluations – Heliyon , www.cell.com/heliyon - Abdullah E Yuzbasioglu et al Muhammad Aziz , Agung Tri Wijayanta , Asep Bayu Dani Nandiyanto. Ammonia as Effective Hydrogen Storage: A Review on Production, Storage and Utilization. *Energies* – 12 June 2020
- [39] MAN – B&W <https://www.man-es.com/docs/default-source/marine/tools/man-b-w-two-stroke-engine-operating-on-ammonia.pdf>
- [40] Article - https://netl.doe.gov/sites/default/files/netl-file/ACT_0324_Wilche.pdf
- [41] Wartsila - <https://www.wartsila.com/marine/decarbonisation/partnerships-and-project-involvement/demo2000>
- [42] The Impact of Ammonia Fuel on Marine Engine Lubrication: An Artificial Lubricant Ageing Approach – et al https://www.researchgate.net/publication/369888542_The_Impact_of_Ammonia_Fuel_on_Marine_Engine_Lubrication_An_Artificial_Lubricant_Ageing_Approach
- [43] ABS Sustainability Whitepaper Ammonia as a Marine Fuel October 2020 https://safety4sea.com/wp-content/uploads/2021/01/Ammonia_as_Marine_Fuel_Whitepaper_20188.pdf
- [44] Preliminary discussion report on the use of Ammonia as fuel for ships <https://www.maritimetechnologiesforum.com/documents/ammonia-report.pdf>
- [45] National Library of Medicine <https://www.ncbi.nlm.nih.gov/books/NBK207883/>
- [46] MAN Energy Solutions – Ship operation using LPG and Ammonia as fuel on MAN B&W dual fuel MELGIP engines- Presentation by Rene Sejer Laursen – 30 Oct. 2018
- [47] The National Institute for occupational safety and health (NIOSH) <https://www.cdc.gov/niosh/npg/npgd0028.html>
- [48] MAN ES technical paper, Engineering the future two-stroke green-ammonia engine, November 2019
- [49] https://www.researchgate.net/publication/369888542_The_Impact_of_Ammonia_Fuel_on_Marine_Engine_Lubrication_An_Artificial_Lubricant_Ageing_Approach ResearchGate - Adam Agcos et al
- [50] Lubricant performance and reliability of ammonia fueled IC engines <https://www.sae.org/publications/technical-papers/content/2023-32-0104/-> Nicolas Obrecht, Bruno Griffaton, et al
- [51] Online article Pollution Solutions. Online Feb. 05 – 2014 Author: Chris Sergeant on behalf of Cancer Research UK Cambridge Institute
- [52] IMO rules.com/IGC_CH14.html
- [53] United States National Center for Biotechnology Information
- [54] MAN ES technical paper – Engineering the future two stroke green-ammonia engine, November 2019
- [55] National Institute of Standard and Technology Ammonia. Available online: <https://webbook.nist.gov/cgi/>
- [56] <https://ammoniaenergy.org/articles/ammonia-for-fuel-cells-a-literature-review/> Ammonia for Fuel Cells: a literature review By Trevor Brown on October 04, 2018
- [57] Lan, R.; Tao, S. Ammonia as a Suitable Fuel for Fuel

- Cells. *Front Energy Res.* 2014, 2.
- [58] MAN ES technical paper – Engineering the future two stroke green-ammonia engine, November 2019
- [59] Ammonia Energy Association article by Julion Atchison 6th Feb. 2024
- [60] Alfa Laval. Press release. The Alfa Laval FCM LPG Booster System Excels with the New LPG-Fuelled Engine from MAN Energy Solutions; Alfa Laval: Lund, Sweden, 2019.
- [61] Offshore Vessel to Run on Ammonia-Powered Fuel Cell. Available online: <https://www.maritime-executive.com/article/offshore-vessel-to-run-on-ammonia-powered-fuel-cell>
- [62] The Crown (Department for Transport). *Clean Maritime Plan*; The Crown: London, UK, 2019.
- [63] Hunter, H.M.A.; Makepeace, J.W.; Wood, T.J.; Mylius, O.S.; Kibble, M.G.; Nutter, J.B.; Jones, M.O.; David, Demonstrating Hydrogen Production from Ammonia Using Lithium Imide—Powering a Small Proton Exchange Membrane Fuel Cell. *J. Power Sources* 2016, 329, 138–147.
- [64] IMO – MEPC 77/6/1 – 20 August 202.
- [65] Lloyd’s Register (LR) & University Maritime Advisory Services (UMAS). *Zero-Emission Vessels 2030—How Do We Get There*; LR: London, UK; UMAS: London, UK, 2017.
- [66] Det Norske Veritas , White paper 2020
- [67] Qiuwen Wang, Hu Zhang, Jiabei Huang and Pengfei Zhang. The use of alternative fuels for maritime decarbonization: Special marine environmental risks and solutions from an international law perspective.
- [68] Acute Exposure Guideline Levels for Selected Airborne Chemicals: Volume 6. <http://www.nap.edu/catalog/12018.html>